

PNP Germanium RF Transistor

AF 139

- SIEMENS AKTIENGESELLSCHAFT ——— T-31-07

for input stages, mixer and oscillator stages up to 860 MHz

AF 139 is a germanium PNP mesa transistor in TO 92 case (18 A 4 DIN 41876). The leads are electrically insulated from the case.

Type	Ordering code
AF 139	Q60106-X139

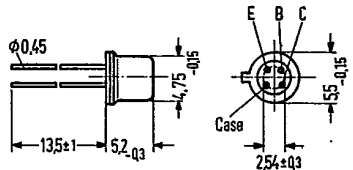

Approx. weight 0.4 g      Dimensions in mm

Maximum ratings

Collector-emitter voltage	$-V_{CE0}$	15	V
Collector-base voltage	$-V_{CBO}$	20	V
Emitter-base voltage	$-V_{EBO}$	0.3	V
Collector current	$-I_C$	10	mA
Emitter current	$I_E$	11	mA
Base current	$-I_B$	1	mA
Junction temperature	$T_J$	90	°C
Storage temperature range	$T_{stg}$	-30 to +75	°C
Total power dissipation ( $T_{amb} = 45^\circ\text{C}$ )	$P_{tot}$	60	mW

Thermal resistance

Junction to ambient air	$R_{thJA}$	$\leq 750$	K/W
Junction to case	$R_{thJC}$	$\leq 400$	K/W

D AF 139  
T-31-07

**Static characteristics** ( $T_{amb} = 25^{\circ}\text{C}$ )

$-V_{CE}$ V	$-I_C$ mA	$-I_B$ $\mu\text{A}$	$h_{FE}$ $I_C/I_B$	$-V_{BE}$ mV
12	1.5	30	50 (>10)	380 (320 to 430)
6	2	36	55	380 (320 to 430)
6	5	66	75	405 (360 to 450)

Collector cutoff current ( $-V_{CBO} = 20\text{ V}$ )	$-I_{CBO}$	0.5 (<8)	$\mu\text{A}$
Emitter cutoff current ( $-V_{EBO} = 0.3\text{ V}$ )	$-I_{EBO}$	2 (<100)	$\mu\text{A}$
Collector cutoff current ( $-V_{CEO} = 15\text{ V}$ )	$-I_{CEO}$	<500	$\mu\text{A}$

**Dynamic characteristics** ( $T_{amb} = 25^{\circ}\text{C}$ )

Operating point:  $-I_C = 1.5\text{ mA}$ ;  $-V_{CE} = 12\text{ V}$ .

Transition frequency ( $f = 100\text{ MHz}$ )

Feedback time constant ( $f = 2.5\text{ MHz}$ )

Max. frequency of oscillation $f_{max} = \sqrt{\frac{f_T}{8\pi \cdot r_{bb'} \cdot C_{b'c}}}$	$f_T$	550	MHz
	$r_{bb'} \cdot C_{b'c}$	3	ps
	$f_{max}$	2.7	GHz
Reverse transfer capacitance ( $f = 450\text{ kHz}$ )	$-C_{12e}$	0.25	pF
Power gain ( $f = 800\text{ MHz}$ ; $R_L = 1.4\text{ k}\Omega$ )	$G_{pb}^{1)}$	11 (>9)	dB
Power gain ( $f = 900\text{ MHz}$ )	$G_{pb}$	9 (>6.5)	dB
Feedback damping ( $f = 800\text{ MHz}$ )	$-G_{pb}^{binv}^{1)}$	23	dB
Noise figure ( $f = 800\text{ MHz}$ ; $R_g = 60\text{ }\Omega$ )	$NF^{1)}$	7 (<8.2)	dB
Noise figure ( $f = 900\text{ MHz}$ ; $R_L = 0.5\text{ k}\Omega$ ; $-V_{CE} = 10\text{ V}$ ; $I_E = 2\text{ mA}$ )	$NF$	7.5 ( $\leq 9$ )	dB

**Four-pole characteristics:**

$-I_C = 1.5\text{ mA}$ ;  $-V_{CE} = 12\text{ V}$ ;  $f = 200\text{ MHz}$

$g_{11b} = 28\text{ mS}$	$-g_{12b} = 0.06\text{ mS}$	$-g_{21b} = 22\text{ mS}$	$g_{22b} = 0.09\text{ mS}$
$-b_{11b} = 24\text{ mS}$	$-b_{12b} = 0.16\text{ mS}$	$b_{21b} = 30\text{ mS}$	$b_{22b} = 1.9\text{ mS}$

$-I_C = 1.5\text{ mA}$ ;  $-V_{CE} = 12\text{ V}$ ;  $f = 800\text{ MHz}$

$g_{11b} = 7\text{ mS}$	$y_{12b} = 0.4\text{ mS}$	$ y_{21b}  = 14\text{ mS}$	$g_{22b} = 0.5\text{ mS}$
$-b_{11b} = 11\text{ mS}$	$\varphi_{12b} = -120^{\circ}$	$\varphi_{21b} = 35^{\circ}$	$b_{22b} = 7.5\text{ mS}$

1) measured in circuit shown on page 108

Test circuit for power gain and noise figure at  $f = 200$  MHz

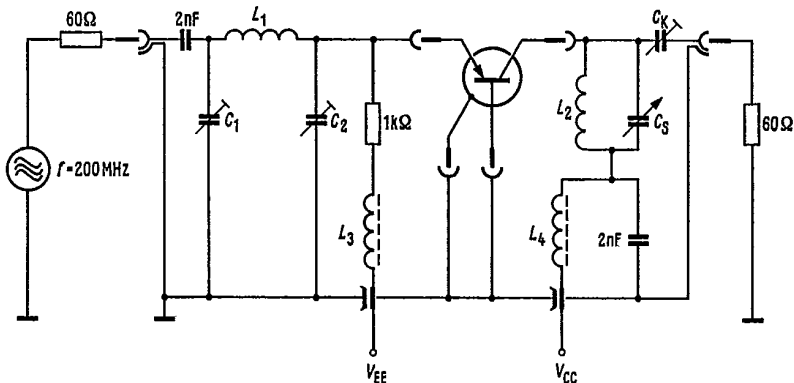

- $L_1 = 3$  turns;  $d = 1$  mm; dia = 6.5 mm
- $L_2 = 2$  turns;  $d = 1$  mm; dia = 6.5 mm
- $L_3 = L_4 = 20$  turns 0.5 CuLs on core B63310-K1-A12.3
- $C_K = 1.5$  to 5 pF so that  $R_L = 920 \Omega$
- $C_1 = 6.5$  to 18 pF
- $C_2 = 9.5$  to 20 pF
- $C_3 = 3$  to 10 pF

Test circuit for power gain and noise figure at  $f = 800$  MHz

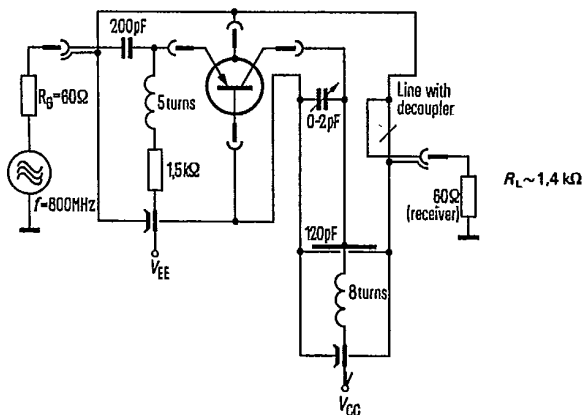

T-31-07

Total perm. power dissipation versus temperature  
 $P_{tot} = f(T); R_{th} = \text{parameter}$

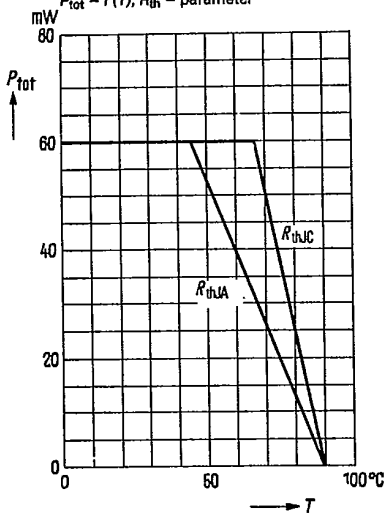

Input characteristic  $I_B = f(V_{BE}); -V_{CE} = 5V$   
 (common emitter configuration)

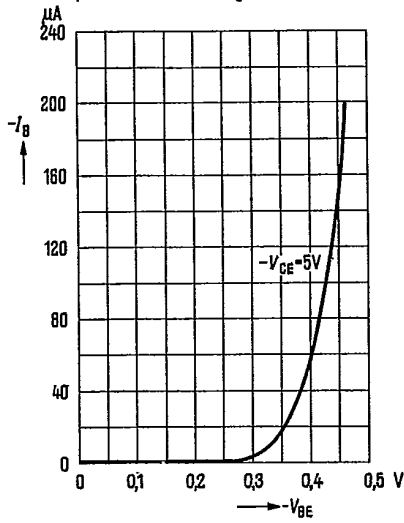

Collector current  $I_C = f(I_B); -V_{CE} = 5V$   
 (common emitter configuration)

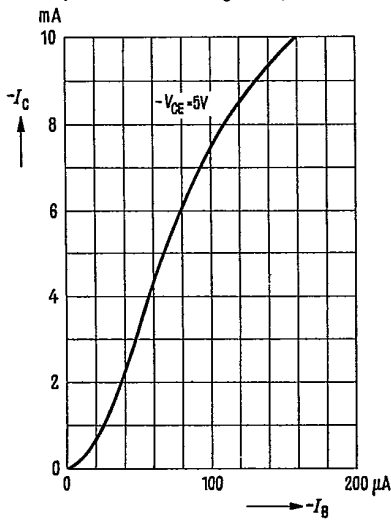

Collector current  $I_C = f(V_{BE}); -V_{CE} = 5V$   
 (common emitter configuration)

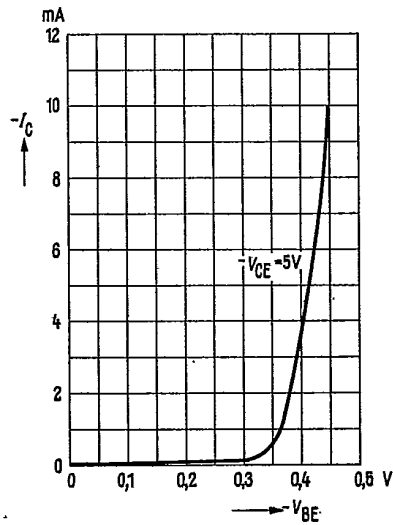

Output characteristics  $I_C = f(V_{CE})$ ;  
 $I_B$  = parameter  
 (common emitter configuration)

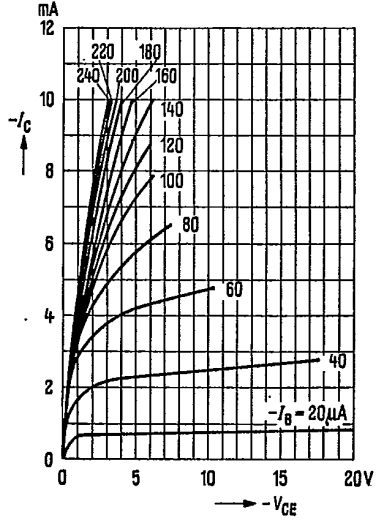

Output characteristics  $I_C = f(V_{CB})$ ;  
 $I_E$  = parameter  
 (common base configuration)

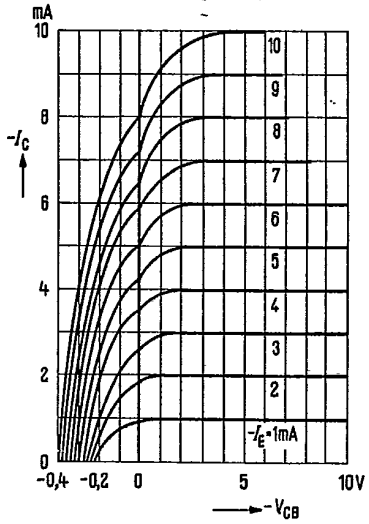

Collector cutoff current  $I_{CBO} = f(T_{amb})$ ;  
 versus temperature  
 $-V_{CBO} = 20 V$

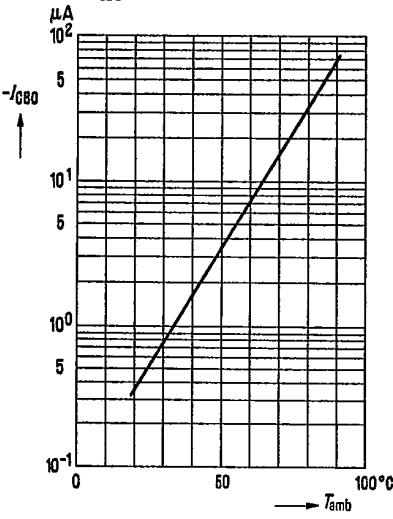

Transition frequency  $f_T = f(I_C)$ ;  
 $V_{CE}$  = parameter

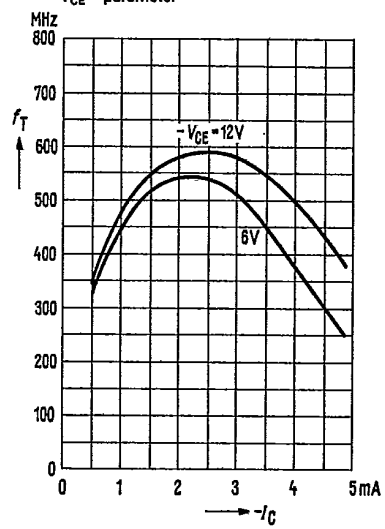

1)  $V_{int 1\%}$  is the rms value of half the EMF (terminal voltage under matching condition) of a 100% sine wave modulated TV-carrier at a generator impedance of  $240 \Omega$  which causes a 1% amplitude modulation on the signal carrier.

Interference voltage  $V_{int 1\%} = f(I_C)$   
 Power gain  $G_{pb} = f(I_C)$   
 $f = 200 \text{ MHz}; -V_{batt} = 12 \text{ V}; R_V = 1 \text{ k}\Omega;$   
 $R_L = 0.9 \text{ k}\Omega$  (common base configuration)

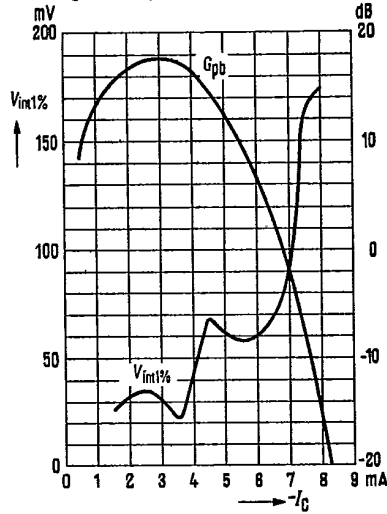

Power gain  $G_{pb} = f(I_C)$   
 $f = 800 \text{ MHz}; -V_{batt} = 12 \text{ V}; R_V = 1 \text{ k}\Omega$   
 $R_L = 1.4 \text{ k}\Omega$   
 (common base configuration)

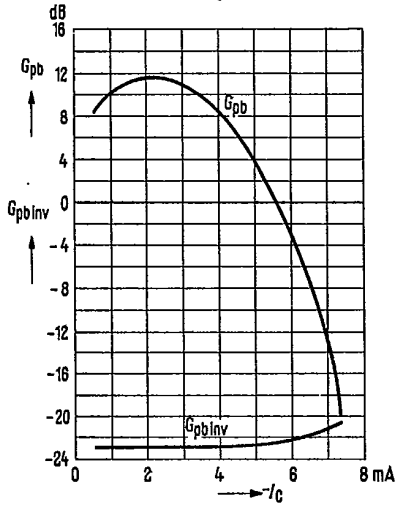

Power gain  $G_{pb} = f(I_C)$   
 $f = 500 \text{ MHz}; -V_{batt} = 12 \text{ V}; R_V = 1 \text{ k}\Omega$   
 $R_L = 1.4 \text{ k}\Omega$   
 (common base configuration)

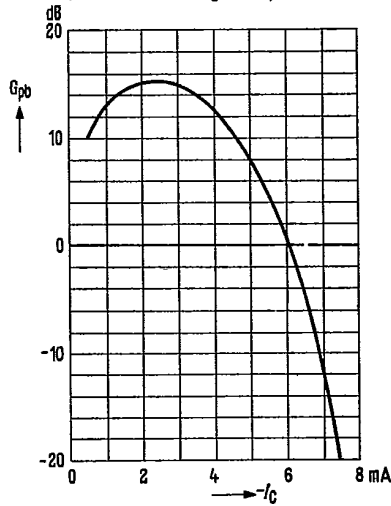

Small signal short circuit input admittance  $y_{11b}$ ;  $-V_{CB} = 12V$   
 (common base configuration)  
 measuring plane 5 mm below case bottom

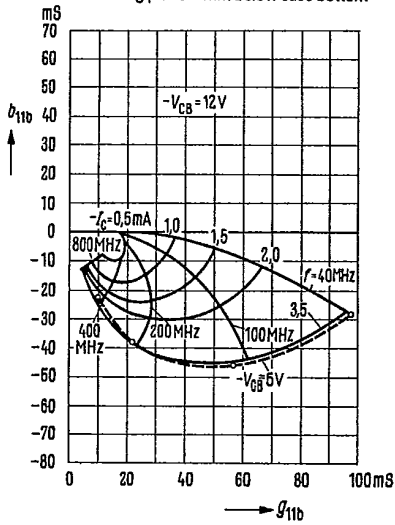

Small signal circuit reverse transfer admittance  $y_{12b}$ ;  $-V_{CB} = 12V$   
 (common base configuration)  
 measuring plane 5 mm below case bottom

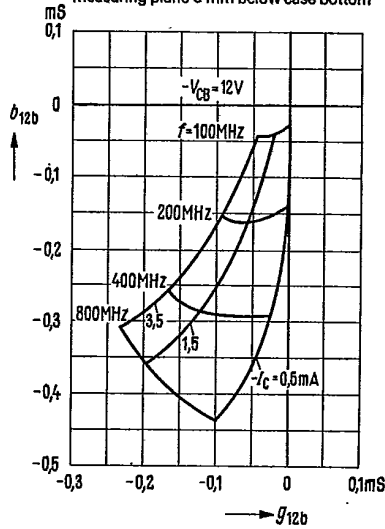

Small signal short circuit forward transfer admittance  $y_{21b}$ ;  $-V_{CB} = 12V$   
 (common base configuration)  
 measuring plane 5 mm below case bottom

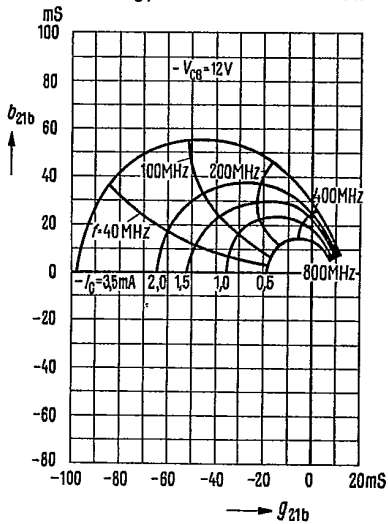

Small signal short circuit output admittance  $y_{22}$ ;  $I_E = 1.5mA$   
 (common emitter, base configuration)  
 measuring plane 5 mm below case bottom

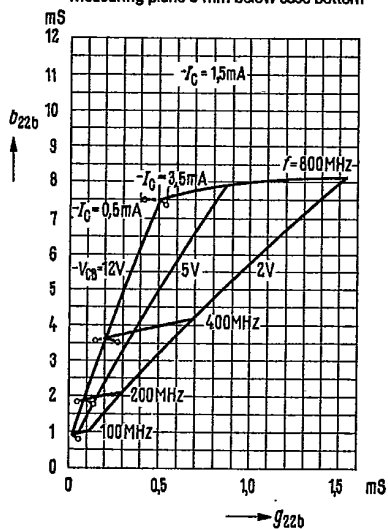

T-31-07

**Power gain versus frequency**  
 $G_{pb\text{opt}} = f(f)$ ;  $-I_C = 1.5 \text{ mA}$ ;  $-V_{CE} = 12 \text{ V}$   
 (common base configuration)

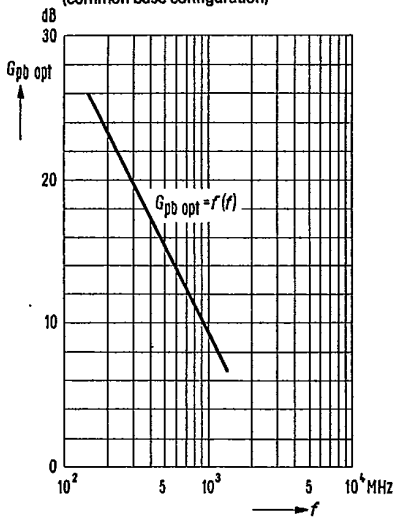

**Noise figure versus frequency  $NF = f(f)$**   
 $-V_{CE} = 12 \text{ V}$   
 $-I_C = 1.5 \text{ mA}$ ;  $R_G = 60 \Omega$

