



NATL SEMICON (LINEAR)

T-79-05-10

## LM748 Operational Amplifier

### General Description

The LM748 is a general purpose operational amplifier with external frequency compensation.

The unity-gain compensation specified makes the circuit stable for all feedback configurations, even with capacitive loads. It is possible to optimize compensation for best high frequency performance at any gain. As a comparator, the output can be clamped at any desired level to make it compatible with logic circuits.

The LM748 is specified for operation over the  $-55^{\circ}\text{C}$  to  $+125^{\circ}\text{C}$  military temperature range. The LM748C is specified for operation over the  $0^{\circ}\text{C}$  to  $+70^{\circ}\text{C}$  temperature range.

### Features

- Frequency compensation with a single 30 pF capacitor
- Operation from  $\pm 5\text{V}$  to  $\pm 20\text{V}$
- Continuous short-circuit protection
- Operation as a comparator with differential inputs as high as  $\pm 30\text{V}$
- No latch-up when common mode range is exceeded
- Same pin configuration as the LM101

### Connection Diagrams

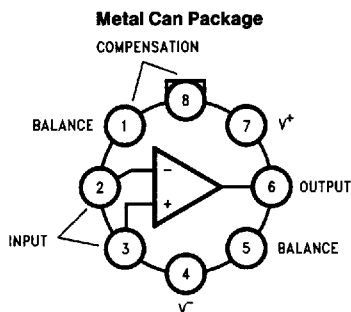

Note: Pin 4 connected to case.

TL/H/11478-1

Top View

Order Number LM748H or LM748CH  
See NS Package Number H08C

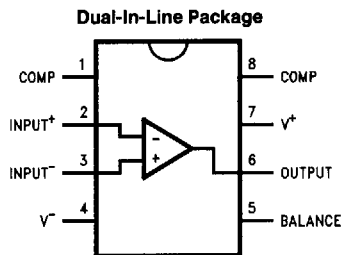

TL/H/11478-2

Top View

Order Number LM748CJ  
See NS Package Number J08A  
Order Number LM748CN  
See NS Package Number N08B

**Absolute Maximum Ratings**

If Military/Aerospace specified devices are required, please contact the National Semiconductor Sales Office/Distributors for availability and specifications.

Supply Voltage	±22V
Power Dissipation (Note 1)	500 mW
Differential Input Voltage	±30V

## NATL SEMICON (LINEAR)

Input Voltage (Note 2)	±15V
Output Short-Circuit Duration (Note 3)	Indefinite
Operating Temperature Range:	
LM748	-55°C to +125°C
LM748C	0°C to +70°C
Storage Temperature Range	-65°C to +150°C
Lead Temperature (Soldering, 10 sec.)	+300°C

**Electrical Characteristics** (Note 4)

Parameter	Conditions	Min	Typ	Max	Units
Input Offset Voltage	$T_A = 25^\circ\text{C}, R_S \leq 10\text{ k}\Omega$		1.0	5.0	mV
Input Offset Current	$T_A = 25^\circ\text{C}$		40	200	nA
Input Bias Current	$T_A = 25^\circ\text{C}$		120	500	nA
Input Resistance	$T_A = 25^\circ\text{C}$	300	800		k $\Omega$
Supply Current	$T_A = 25^\circ\text{C}, V_S = \pm 15\text{V}$		1.8	2.8	mA
Large Signal Voltage Gain	$T_A = 25^\circ\text{C}, V_S = \pm 15\text{V}$ $V_{\text{OUT}} = \pm 10\text{V}, R_L \geq 2\text{ k}\Omega$	50	160		V/mV
Input Offset Voltage	$R_S \leq 10\text{ k}\Omega$			6.0	mV
Average Temperature Coefficient of Input Offset Voltage	$R_S \leq 50\Omega$		3.0		$\mu\text{V}/^\circ\text{C}$
	$R_S \leq 10\text{ k}\Omega$		6.0		$\mu\text{V}/^\circ\text{C}$
Input Offset Current	$T_A = 0^\circ\text{C to } +70^\circ\text{C}$			300	nA
	$T_A = -55^\circ\text{C to } +125^\circ\text{C}$			500	nA
Input Bias Current	$T_A = 0^\circ\text{C to } +70^\circ\text{C}$			0.8	$\mu\text{A}$
	$T_A = -55^\circ\text{C to } +125^\circ\text{C}$			1.5	$\mu\text{A}$
Supply Current	$T_A = +125^\circ\text{C}, V_S = \pm 15\text{V}$		1.2	2.25	mA
	$T_A = -55^\circ\text{C to } +125^\circ\text{C}$		1.9	3.3	mA
Large Signal Voltage Gain	$V_S = \pm 15\text{V}, V_{\text{OUT}} = \pm 10\text{V}$ $R_L \geq 2\text{ k}\Omega$	25			V/mV
Output Voltage Swing	$V_S = \pm 15\text{V}, R_L = 10\text{ k}\Omega$	±12	±14		V
	$V_S = \pm 15\text{V}, R_L = 2\text{ k}\Omega$	±10	±13		V
Input Voltage Range	$V_S = \pm 15\text{V}$	±12			V
Common-Mode Rejection Ratio	$R_S \leq 10\text{ k}\Omega$	70	90		dB
Supply Voltage Rejection Ratio	$R_S \leq 10\text{ k}\Omega$	77	90		dB

**Note 1:** For operating at elevated temperatures, the device must be derated based on a maximum junction to case thermal resistance of 45°C per watt, or 150°C per watt junction to ambient. (See Curves).

**Note 2:** For supply voltages less than ±15V, the absolute maximum input voltage is equal to the supply voltage.

**Note 3:** Continuous short circuit is allowed for case temperatures to +125°C and ambient temperatures to +70°C.

**Note 4:** These specifications apply for  $\pm 5\text{V} \leq V_S \leq \pm 15\text{V}$  and  $-55^\circ\text{C} \leq T_A \leq 125^\circ\text{C}$ , unless otherwise specified. With the LM748C, however, all temperature specifications are limited to  $0^\circ\text{C} \leq T_A \leq +70^\circ\text{C}$ .

NATL SEMICOND (LINEAR)

Typical Applications

Inverting Amplifier with Balancing Circuit

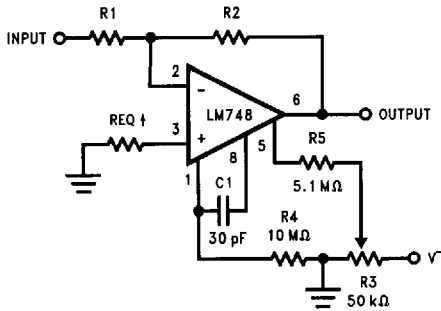

†May be zero or equal to parallel combination of R1 and R2 for minimum offset.

TL/H/11478-3

Voltage Comparator for Driving DTL or TTL Integrated Circuits

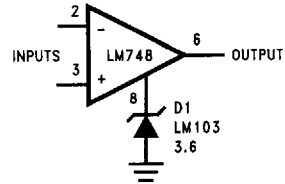

TL/H/11478-4

Voltage Comparator for Driving RTL Logic or High Current Driver

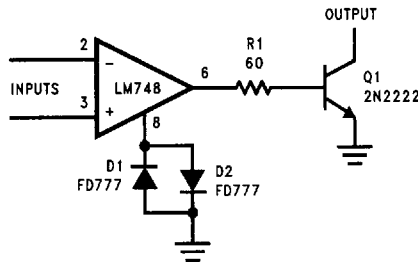

TL/H/11478-5

Guaranteed Performance Characteristics (Note 4)

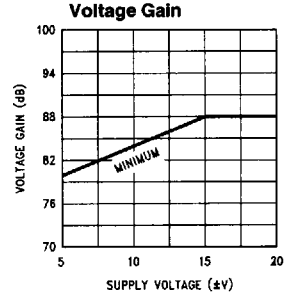
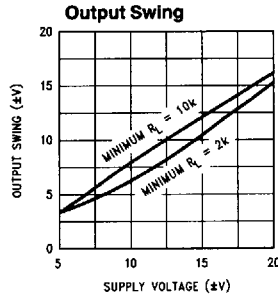
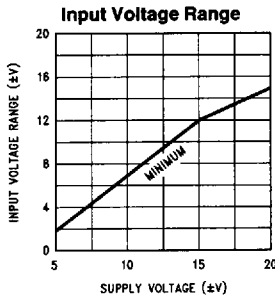

TL/H/11478-6

Typical Performance Characteristics

Supply Current

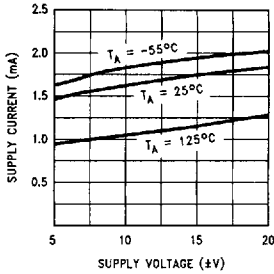

Voltage Gain

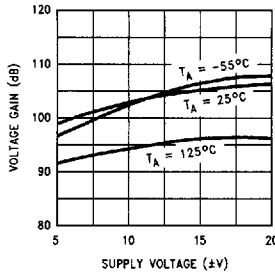

Input Bias Current

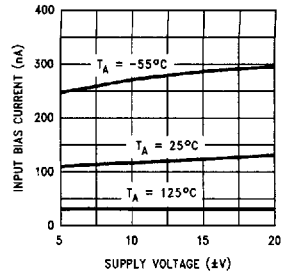

Current Limiting

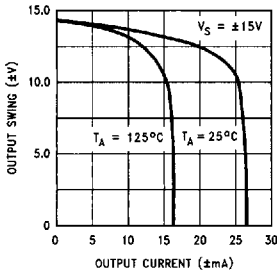

Input Current

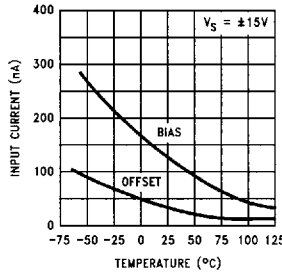

Maximum Power Dissipation

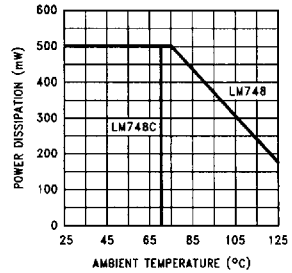

Open Loop Frequency Response

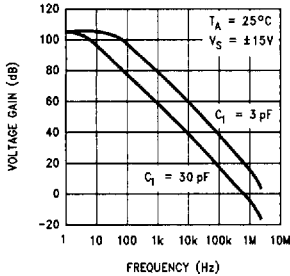

Large Signal Frequency Response

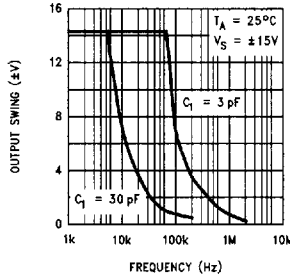

Voltage Follower Pulse Response

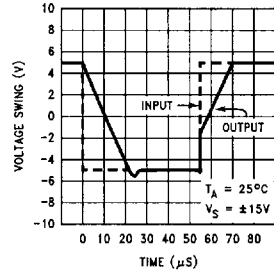

TL/H/11478-7