

MOTOROLA

4096-BIT STATIC RANDOM ACCESS MEMORY

The MCM2114 is a 4096-bit random access memory fabricated with high density, high reliability N-channel silicon-gate technology. For ease of use, the device operates from a single power supply, is directly compatible with TTL and DTL, and requires no clocks or refreshing because of fully static operation. Data access is particularly simple, since address setup times are not required. The data out has the same polarity as the input data.

The MCM2114 is designed for memory applications where simple interfacing is the design objective. The MCM2114 is assembled in 18-pin dual in-line packages with the industry standard pin-out. A separate chip select (\bar{S}) lead allows easy selection of an individual package when the three-state outputs are OR-tied.

The MCM2114 series has a maximum power dissipation of 525 mW. Low power versions (i.e., MCM21L14 series) are available with a maximum power dissipation of less than 370 mW.

- 1024 Words by 4-Bit Organization
- Industry Standard 18-Pin Configuration
- Single +5 Volt Supply
- No Clock or Timing Strobe Required
- Fully Static: Cycle Time = Access Time
- Fully TTL/DTL Compatible
- Common Data Input and Output
- Three-State Outputs for OR-Ties
- Low Power Version Available -- 370 mW (Max)

MAXIMUM ACCESS TIME/MINIMUM CYCLE TIME

MCM2114-20	200 ns	MCM2114-30	300 ns
MCM21L14-20		MCM21L14-30	
MCM2114-25	250 ns	MCM2114-45	450 ns
MCM21L14-25		MCM21L14-45	

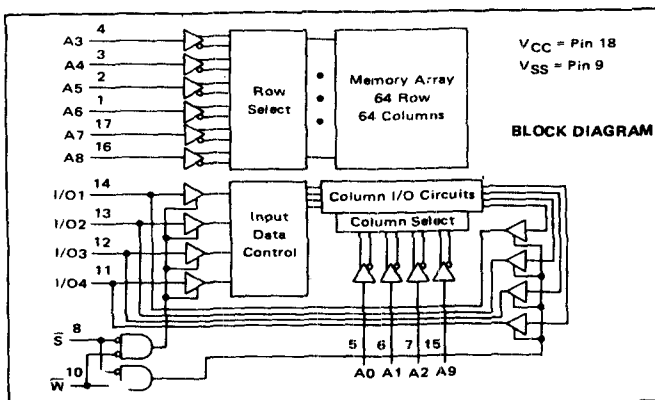

MCM2114

MCM21L14

MOS

(IN-CANNEL, SILICON-GATE)

4096-BIT STATIC RANDOM ACCESS MEMORY

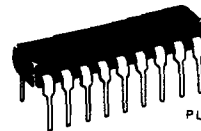

P SUFFIX
PLASTIC PACKAGE
CASE 707



C SUFFIX
FRIT SEAL
CERAMIC PACKAGE
CASE 701

PIN ASSIGNMENT

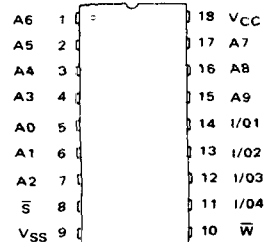

PIN NAMES

A0 - A9	Address Input
W	Write Enable
\bar{S}	Chip Select
I/O1 - I/O4	Data Input/Output
VCC	Power (+5 V)
VSS	Ground

ABSOLUTE MAXIMUM RATINGS (See Note 1)

Rating	Value	Unit
Temperature Under Bias	-10 to +80	°C
Voltage on Any Pin With Respect to V _{SS}	-0.5 to +7.0	Vdc
DC Output Current	5.0	mA
Power Dissipation	1.0	Watt
Operating Temperature Range	-0 to +70	°C
Storage Temperature Range	-65 to +150	°C

This device contains circuitry to protect the inputs against damage due to high static voltages or electric fields; however, it is advised that normal precautions be taken to avoid application of any voltage higher than maximum rated voltages to this high-impedance circuit.

Note: 1. Permanent device damage may occur if ABSOLUTE MAXIMUM RATINGS are exceeded. Functional operation should be restricted to RECOMMENDED OPERATING CONDITIONS. Exposure to higher than recommended voltages for extended periods of time could affect device reliability.

DC OPERATING CONDITIONS AND CHARACTERISTICS

(T_A = 0 to 70°C, V_{CC} = 5.0 V ± 5% unless otherwise noted.)

RECOMMENDED DC OPERATING CONDITIONS

Parameter	Symbol	MCM2114			MCM21L14			Unit
		Min	Nom	Max	Min	Nom	Max	
Input Load Current (All Input Pins, V _{in} = 0 to 5.5 V)	I _{LI}	-	-	10	-	-	10	µA
I/O Leakage Current (\bar{S} = 2.4 V, V _{I/O} = 0.4 V to V _{CC})	I _{LO}	-	-	10	-	-	10	µA
Power Supply Current (V _{in} = 5.5, I _{I/O} = 0 mA, T _A = 25°C)	I _{CC1}	-	80	95	-	-	65	mA
Power Supply Current (V _{in} = 5.5 V, I _{I/O} = 0 mA, T _A = 0°C)	I _{CC2}	-	-	100	-	-	70	mA
Input Low Voltage	V _{IL}	-0.5	-	0.8	-0.5	-	0.8	V
Input High Voltage	V _{IH}	2.0	-	6.0	2.0	-	6.0	V
Output Low Current V _{OL} = 0.4 V	I _{OL}	2.1	6.0	-	2.1	6.0	-	mA
Output High Current V _{OH} = 2.4 V	I _{OH}	-	-1.4	-1.0	-	-1.4	-1.0	mA
Output Short Circuit Current	I _{OS} ⁽²⁾	-	-	40	-	-	40	mA

Note: 2. Duration not to exceed 30 seconds.

CAPACITANCE

(f = 1.0 MHz, T_A = 25°C, periodically sampled rather than 100% tested.)

Characteristic	Symbol	Max	Unit
Input Capacitance (V _{in} = 0 V)	C _{in}	5.0	pF
Input/Output Capacitance (V _{I/O} = 0 V)	C _{I/O}	5.0	pF

AC OPERATING CONDITIONS AND CHARACTERISTICS

(Full operating voltage and temperature unless otherwise noted.)

Input Pulse Levels 0.8 Volt to 2.4 Volts
 Input Rise and Fall Times 10 ns
 Input and Output Timing Levels 1.5 Volts
 Output Load 1 TTL Gate and C_L = 100 pF

MCM2114, MCM21L14

AC OPERATING CONDITIONS AND CHARACTERISTICS Read (Note 3), Write (Note 4) Cycles

RECOMMENDED AC OPERATING CONDITIONS ($T_A = 0$ to 70°C , $V_{CC} = 5.0\text{ V} \pm 5\%$)

Parameter	Symbol	MCM2114-20 MCM21L14-20		MCM2114-25 MCM21L14-25		MCM2114-30 MCM21L14-30		MCM2114-45 MCM21L14-45		Units
		Min	Max	Min	Max	Min	Max	Min	Max	
Read Cycle Time	t_{RC}	200	—	250	—	300	—	450	—	ns
Access Time	t_A	—	200	—	250	—	300	—	450	ns
Chip Selection to Output Valid	t_{SO}	—	70	—	85	—	100	—	120	ns
Chip Selection to Output Active	t_{SX}	20	—	20	—	20	—	20	—	ns
Output 3-State From Deselection	t_{OTD}	—	60	—	70	—	80	—	100	ns
Output Hold From Address Change	t_{OHA}	50	—	50	—	50	—	50	—	ns
Write Cycle Time	t_{WC}	200	—	250	—	300	—	450	—	ns
Write Time	t_W	120	—	135	—	150	—	200	—	ns
Write Release Time	t_{WR}	0	—	0	—	0	—	0	—	ns
Output 3-State From Write	t_{OTW}	—	60	—	70	—	80	—	100	ns
Data to Write Time Overlap	t_{DW}	120	—	135	—	150	—	200	—	ns
Data Hold From Write Time	t_{DH}	0	—	0	—	0	—	0	—	ns

- Notes: 3. A Read occurs during the overlap of a low \bar{S} and a high \bar{W} .
4. A Write occurs during the overlap of a low \bar{S} and a low \bar{W} .

READ CYCLE TIMING (Note 5)

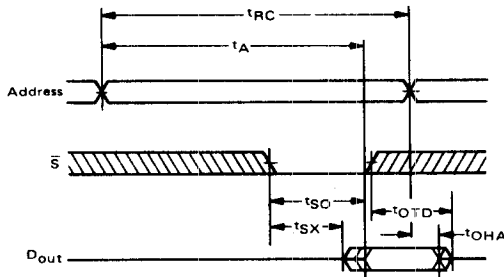

- Notes: 5. \bar{W} is high for a Read cycle.

WRITE CYCLE TIMING (Note 6)

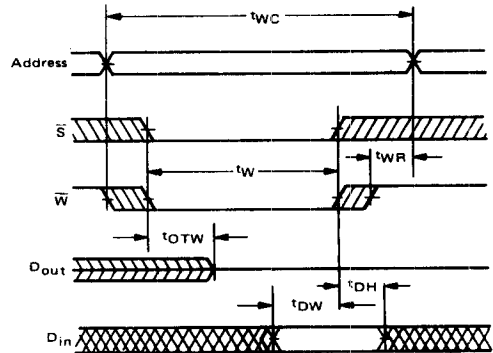

6. If the \bar{S} low transition occurs simultaneously with the \bar{W} low transition, the output buffers remain in a high impedance rate.

WAVEFORMS

Waveform Symbol	Input	Output
—	MUST BE VALID	WILL BE VALID
▨	CHANGE FROM H TO L	WILL CHANGE FROM H TO L
▩	CHANGE FROM L TO H	WILL CHANGE FROM L TO H
▧	DON'T CARE ANY CHANGE PERMITTED	CHANGING STATE UNKNOWN
⊏		HIGH IMPEDANCE

Supply Current vs Supply Voltage

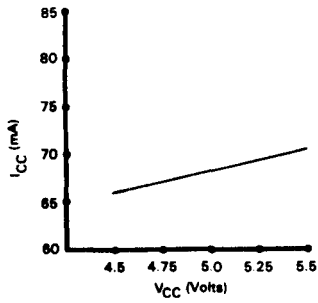

Supply Current vs Ambient Temp

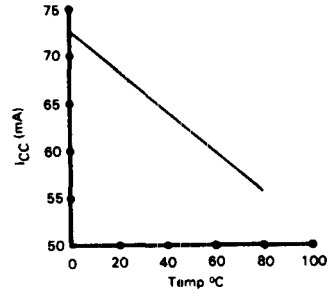

Output Source Current vs Output Voltage

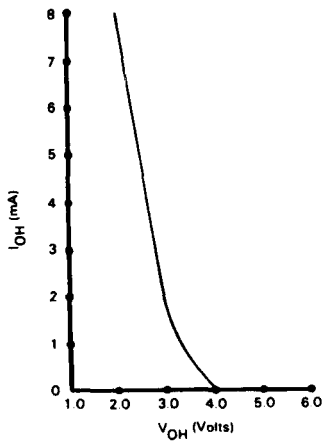

Output Sink Current vs Output Voltage

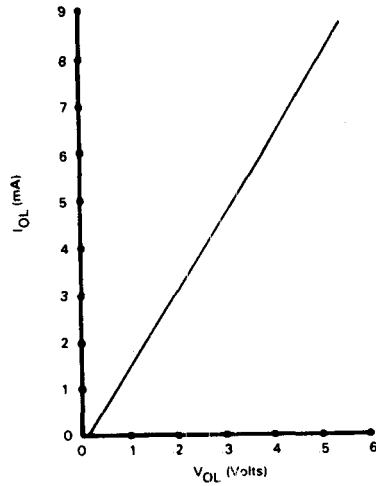

Normalized T_{ACC} vs Temperature

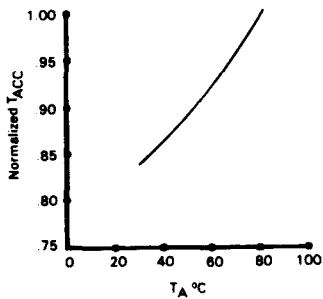

Typical T_{ACC} vs Temp

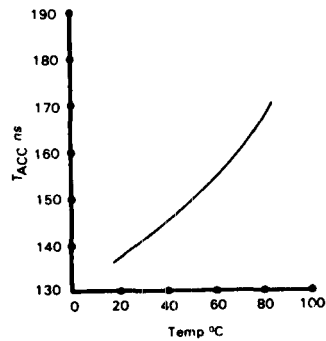

PACKAGE DIMENSIONS

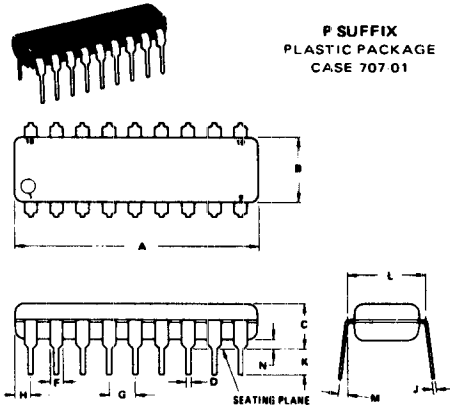

P SUFFIX
PLASTIC PACKAGE
CASE 707-01

DIM	MILLIMETERS		INCHES	
	MIN	MAX	MIN	MAX
A	22.22	23.34	0.875	0.915
B	6.90	7.31	0.260	0.280
C	4.98	4.97	0.190	0.190
D	0.30	0.51	0.014	0.020
F	1.93	1.92	0.060	0.060
G	2.41	2.47	0.090	0.100
H	1.14	1.40	0.040	0.050
J	0.20	0.30	0.000	0.012
K	2.95	3.56	0.110	0.140
L	7.57	7.87	0.290	0.310
M	ØP	1ØP	ØP	1ØP
N	0.51	1.02	0.020	0.040

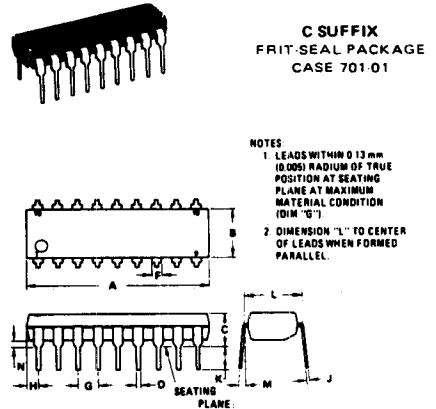

C SUFFIX
FRIT-SEAL PACKAGE
CASE 701-01

- NOTES
- LEADS WITHIN 0.13 mm (0.005) RADIUS OF TRUE POSITION AT SEATING PLANE AT MAXIMUM MATERIAL CONDITION (DIM "D").
 - DIMENSION "L" TO CENTER OF LEADS WHEN FORMED PARALLEL.

DIM	MILLIMETERS		INCHES	
	MIN	MAX	MIN	MAX
A	22.11	23.00	0.910	0.940
B	6.10	6.50	0.240	0.260
C	4.90	4.97	0.190	0.190
D	0.30	0.51	0.010	0.020
F	1.90	1.92	0.060	0.060
G	1.64 REF	0.100	0.065	
H	1.32	1.60	0.050	0.072
J	0.20	0.30	0.000	0.012
K	2.82	3.43	0.110	0.130
L	7.57	7.87	0.290	0.310
M	ØP	1ØP	ØP	1ØP
N	0.51	1.02	0.020	0.040